

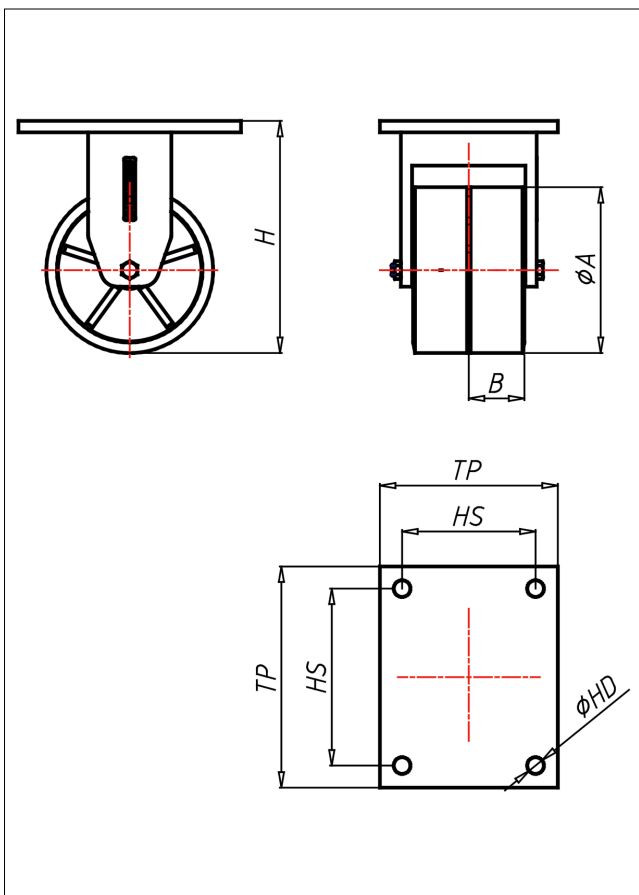

# EDDF/ESF-ZK/ZZK

## Bockrolle

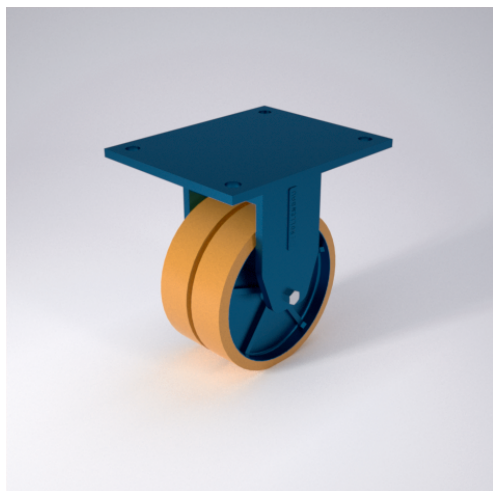

### EDD-Z



LENKROLLE	Feststeller TLCH Seite 42	BOCKROLLE																				
<ul style="list-style-type: none"> <li>geräuscharmer Lauf</li> <li>geringer Rollwiderstand</li> <li>abrieb- und reißfest</li> <li>hohe Stoßfestigkeit</li> <li>sehr beständig gegen viele aggressive Medien</li> </ul> Guss-Polyurethan Felge Gusseisen lackiert → Seite 245	Schrägrollen- und Axialkugellager, staubgeschützt, sehr starker Zentralbolzen, Mütter gesichert, Schmiempfel Ausführung – lackiert → Seite 26	AUSWAHLHILFE: <table border="0"> <tr> <td>leicht lenkend</td> <td><input type="radio"/></td> <td><input checked="" type="radio"/></td> <td><input type="radio"/></td> </tr> <tr> <td>verschleißarm</td> <td><input type="radio"/></td> <td><input checked="" type="radio"/></td> <td><input type="radio"/></td> </tr> <tr> <td>stoßfest</td> <td><input type="radio"/></td> <td><input checked="" type="radio"/></td> <td><input type="radio"/></td> </tr> <tr> <td>bodenschonend</td> <td><input type="radio"/></td> <td><input checked="" type="radio"/></td> <td><input type="radio"/></td> </tr> <tr> <td>witterungsbeständig</td> <td><input type="radio"/></td> <td><input checked="" type="radio"/></td> <td><input type="radio"/></td> </tr> </table>	leicht lenkend	<input type="radio"/>	<input checked="" type="radio"/>	<input type="radio"/>	verschleißarm	<input type="radio"/>	<input checked="" type="radio"/>	<input type="radio"/>	stoßfest	<input type="radio"/>	<input checked="" type="radio"/>	<input type="radio"/>	bodenschonend	<input type="radio"/>	<input checked="" type="radio"/>	<input type="radio"/>	witterungsbeständig	<input type="radio"/>	<input checked="" type="radio"/>	<input type="radio"/>
leicht lenkend	<input type="radio"/>	<input checked="" type="radio"/>	<input type="radio"/>																			
verschleißarm	<input type="radio"/>	<input checked="" type="radio"/>	<input type="radio"/>																			
stoßfest	<input type="radio"/>	<input checked="" type="radio"/>	<input type="radio"/>																			
bodenschonend	<input type="radio"/>	<input checked="" type="radio"/>	<input type="radio"/>																			
witterungsbeständig	<input type="radio"/>	<input checked="" type="radio"/>	<input type="radio"/>																			

### Technische Details

<b>ORDERNO (Artikel-nummer)</b>	EDDF 251 ZZK
<b>WDAB (Rad-Ø A x Breite B / mm)</b>	250x80+80
<b>LC (Tragkraft / kg)</b>	3500
<b>H (Bauhöhe H / mm)</b>	356
<b>TP (Plattengröße / mm)</b>	255x205
<b>HS (Lochabstand / mm)</b>	210x160
<b>HD (Loch-Ø / mm)</b>	17
<b>WB (Radlager)</b>	Kugellager